

INSTALLATION GUIDE

Magnetic tape Series WB, WBA, WBAX and WBAZ

For more information please see the data sheet at
www.waycon.biz/products/digital-rulers/

FIRST STEPS

WayCon Positionsmesstechnik GmbH would like to thank you for the trust you have placed in us and our products. This manual will make you familiar with the installation and operation of our magnetic scale sensors. Please read this manual carefully before initial operation!

Unpacking and checking:

After unpacking the device, check it for any visible damage as a result of rough handling during the shipment. Check the delivery for completeness.

If necessary consult the transportation company, or contact WayCon directly for further assistance.

SAFETY

- Installation and maintenance have to be carried out by qualified personnel only.
- During installation and maintenance make sure that the machine is not running and the power supply is OFF.
- The device must be used only for the purpose appropriate to its design. The use for purposes other than those for which it has been designed could result in serious personal and/or the environment damages.
- Failure to comply with these precautions or with specific warnings elsewhere in this guide violates safety standards of design, manufacture, and intended use of the equipment.
- WayCon assumes no liability for the customer's failure to comply with these requirements.

WARNINGS

- **Equipment that produces strong magnetic fields must be kept as far from the tape as possible. Do not bring magnets close to the tape.**
- Install the magnetic tape strictly following the information in this guide.
- Mechanical installation has to be carried out only when the machine is switched off.
- Do not tool or machine the unit unless otherwise indicated.
- Do not twist or bend the magnetic tape.
- Always comply with the tape's bending radius values indicated in this guide.
- During installation we suggest protecting the device against pollution, like chips, filings or liquids. Should this be impossible, please make sure that adequate cleaning measures (as for instance brushes, scrapers, jets of compressed air, etc.) are in place in order to prevent the sensor and the magnetic scale from jamming.
- Protect the tape from acid solutions and chemicals that may damage it.

MAGNETIC TAPE STRUCTURE

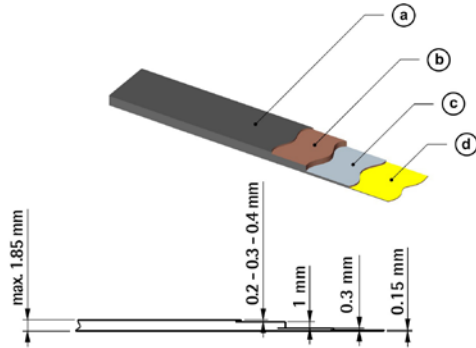

- | | |
|---|----------------------------------------|
| a | Stainless steel cover strip (optional) |
| b | Polymer-ferrite composite strip |
| c | Ferromagnetic stainless steel strip |
| d | Adhesive backing |

Parts (b), (c) and (d) are delivered already stuck together. The stainless steel cover strip (a) is optional and delivered not glued to the tape, thus it must be applied by the customer.

WB10, WB20, WB50 and WBA2 dimensions

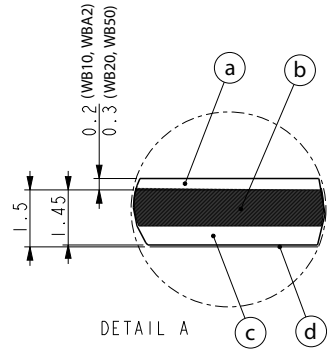
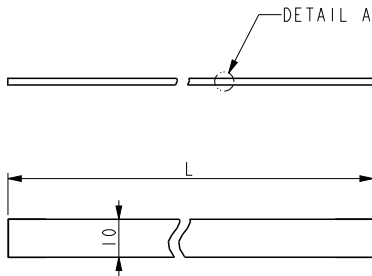

WBAX and WBAZ dimensions

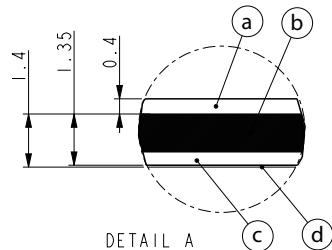
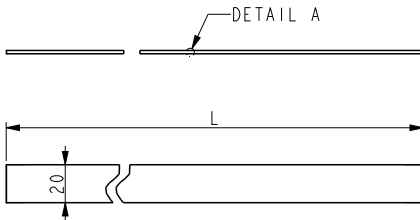

TRANSPORT AND HANDLING

The tape is delivered wound on coils, the magnetized side facing inwards. If supplied, the stainless steel cover strip is delivered separately. It must be applied to the magnetic tape by the customer as described in this guide (refer to the "mounting the magnetic tape" section).

Do not wind the tape with the magnetized side facing outwards.

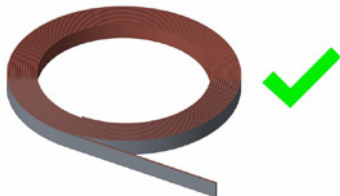

Magnetized surface facing inwards



Magnetized surface facing outwards

Do not twist or bend the magnetic tape



CHEMICAL RESISTANCE

WARNING: Protect the tape from acid solutions and chemicals that may damage it. Please check in the following table the chemicals that have no or low impact, low to medium impact and high impact on the magnetic material of the tape.

No or low impact chemicals

Acetic acid 20%	Acetic acid 30%	Cotton seed oil	Formaldehyde 40%
Formic acid	Glacial acetic acid	Glycerine (93°C)	Hexane
Isooctane	Kerosene	Lactic acid	Linseed oil
Mineral oil	Oleic acid	Soy bean oil	Steam heat
Stearic acid			

Low to medium impact chemicals

Acetone	Acetylene	Anhydrous ammonia	Isopropyl ether
Lacquer solvent	Petrol	Seawater	Turpentine

High impact chemicals

Benzene	Carbon tetrachloride	Hydrochloric acid 37% (93°C)	Nitric acid 70%
Nitrobenzene	Red fuming nitric acid	Tetrahydrofuran	Toluene
Trichloroethylene	Xylene		

Please note: Tolerances also depend on temperature, air supply, duration of impact, liquid consistency and several other factors. Therefore it is always advisable to test the material under real conditions.

PRELIMINARY INFORMATION BEFORE INSTALLATION

WARNING: Always refer to the “Installation Guide” of the matched sensor before installing the magnetic tape. The measuring system cannot work if the encoder and the magnetic tape are mounted differently than indicated in the installation guides.

Before mounting the tape and the cover strip, you must:

- Carefully clean the bonding surface as detailed in “cleaning the bonding surfaces” below.
- Cut the tape and the cover strip at the required length as explained in the “Shortening and cutting the tape and the cover strip” below.
- Do not apply the cover strip to the magnetic tape before they are both cut at the required length.
- Do not cut the tape and the cover strip if they are already bonded together.
- Stick the magnetic tape first, then apply the cover strip to the tape.
- Carefully check the mounting direction of the tape; mounting direction is crucial and binding upon the absolute encoders.
- Carefully check the counting direction and the information printed on the surface of the absolute code tapes as well. Please note down the information on the print and the arrow direction before applying the cover strip.

INFORMATION ON STICKING THE TAPE

The adhesion of the tape to the bonding surface depends on a variety of factors such as the cleaning, the temperature at application, the roughness of the materials and the smoothness of the bonding surface. To obtain optimum and safe adhesion, the bonding surfaces must be well unified, clean and dry.

Cleaning the bonding surfaces:

Most substrates are best prepared by cleaning with a soft and clean cloth and one of the following solvent-based cleaners (alcoholic solvents or hydrocarbon solvents): isopropyl alcohol (IPA), heptane, trichloroethylene (please do not use on aluminium surfaces not to provoke a reaction generating chlorine acids), toluene, acetone and methyl ethyl ketone (MEK). Typical surface cleaning solvent is 50:50 mixture of isopropyl alcohol (IPA) and water (rubbing alcohol). In case of oxidation, Scotch-Brite hand pads or similar products, followed by cleaning with IPA/water, allow to abrade the surface and can increase surface area to improve adhesion.

Application temperature:

Ideal application temperature range is +21°C to +38°C. The minimum suggested application temperature is +10°C. Initial tape application to surfaces at temperatures below the suggested minimum +10°C is not recommended because the adhesive becomes too firm to adhere readily. However, once properly applied, low temperature holding is generally satisfactory. After application, the bond strength will increase as the adhesive flows onto the surface. At room temperature 100% of ultimate bond strength will be achieved after approximately 72 hours.

Bonding surface finish:

As a general rule, we suggest sticking the tape on bonding surfaces that are as much as possible. The surface roughness parameter (surface finish) should be $R_a \leq 3.2$ (Class N8).

Pressure:

Bond strength is dependent upon the amount of adhesive-to-surface contact developed. Firm application pressure develops better adhesive contact and helps improve bond strength. Typically, good surface contact can be attained by applying enough pressure to ensure that the tape experiences approximately 100 kPa pressure. Either roller or platen pressure can be used. Note that rigid surfaces may require 2 or 3 times that much pressure to make the tape experience 100 kPa.

SHORTENING AND CUTTING THE TAPE AND COVER STRIP

Measurement of the tape before cutting:

All the magnetic tapes both incremental and absolute can be shortened and cut at the desired length and according to needs. No limitations are imposed within the maximum length indicated in the data sheet.

The minimum length of the magnetic tape must be calculated as follows (see the Figure):

(c) measuring length + **(b)** sensing head bottom side length + **(a)** the sum of 1 pole pitch + 1 mm.

The sum of the value **(a)** must be doubled as it is intended for each end of the tape.

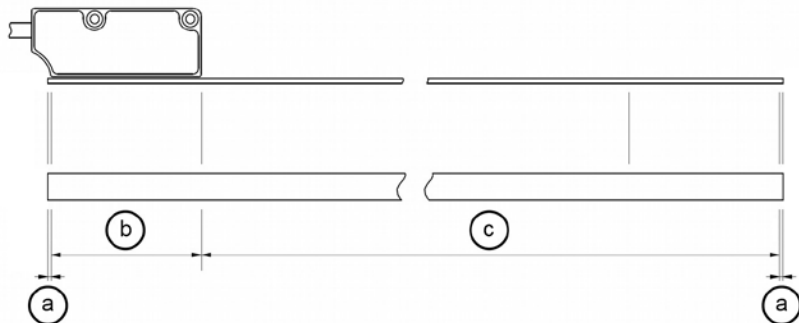

Example for WBA2 + MXS2:

Let's suppose we need to measure a 5000 mm long distance.

This leads to the following values:

$$(a) = 2 \text{ mm (x 2)} \mid (b) = 55 \text{ mm} \mid (c) = 5000 \text{ mm}$$

Thus the minimum length of the tape will be 5059 mm.

Cutting the tape and the cover strip:

Use shears or a metal cutting chop saw to cut the tape and the cover strip. Please consider that the shears' blades will make a clear cut on one side and a warped cut on the other side.

WARNING: Please always cut the tape and the cover strip separately. Do not cut the tape and the cover strip if they are already bonded together.

MOUNTING THE MAGNETIC TAPE

WARNINGS:

- The active side of the magnetic tape (polymer-ferrite composite dark side) must always face the active side of the linear encoder (sensor's location in the enclosure).
- We suggest installing the tape and the sensor providing protection means against waste, especially swarf as turnings, chips, or filings; should this not be possible, please make sure that adequate cleaning measures such as brushes, wipers or compressed air jets are in place in order to prevent the sensor and the tape from jamming.
- Please ensure that the tape is kept in a straight line! We suggest sticking on the tape inside a groove or against an edge.



Step by step procedure for mounting the scale with adhesive tape:

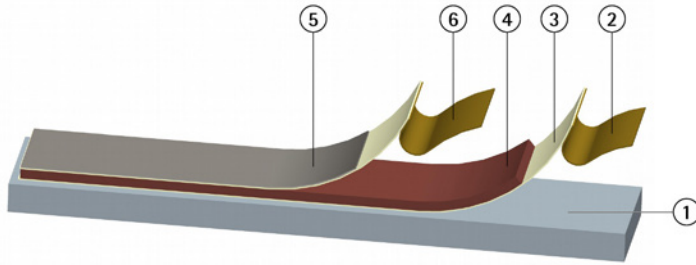

- Cut the magnetic tape (4) to the required length as described in the “Shortening and cutting the tape and the cover strip” section above.
- Carefully clean the bonding surface (1) as described in the “Information on sticking the tape” section above.
- Stick on the magnetic tape (4) first: peel away just a short part of the protection backing (liner) (2) from the adhesive tape (3) and stick on the first part of the tape. Go on sticking short sections until bonding the whole length.

Proceed as follows when you want to apply the optional stainless steel cover strip:

- Cut the cover strip (5) at the required length as described in the “Shortening and cutting the tape and the cover strip” section above.
- Carefully clean the magnetic tape surface (4) as described in the “Information on sticking the tape” section above.
- Stick on the cover strip (5): peel away just a short part of the protection backing (liner) (6) from the adhesive tape and stick on the first part of the cover strip. Go on sticking short sections until bonding the whole length. Apply enough pressure to ensure that the tape experiences approximately 100 kPa pressure. Either roller or platen pressure can be used. For more information refer to the “Pressure” section.

WARNING: With absolute tape, please note down the direction of the arrow that indicates the counting direction before installing the cover strip (5).

Please note that the cover strips have different thickness in specific models:

0,2 mm for WB10 and WBA2

0,3 mm for WB20 and WB50

0,4 mm for WBAX and WBAZ

MOUNTING THE MAGNETIC TAPE

Mounting the tape on arcs and round surfaces (only WB10, WB20 and WB50):

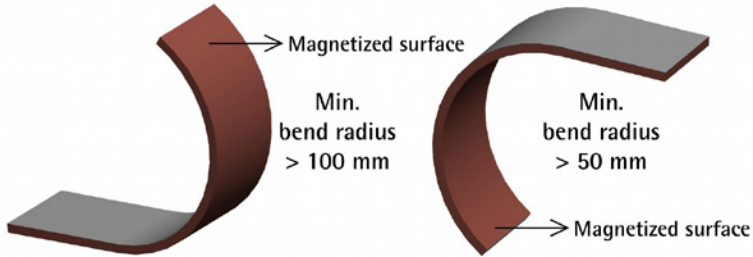

WB10, WB20 and WB50 tapes for incremental encoders can be installed in curved structures, in arcs and even in circular surfaces. If you need to read the outer surface of the arc / circumference, the minimum bend radius must be greater than 100 mm. If you need to read the inner surface of the arc / circumference, the minimum bend radius must be greater than 50 mm. The mounting procedure for circular / angular applications is the same as for linear applications.

WARNING: Please consider that the angular resolution depends on the radius of the curved support. The calculation of this is described below and on the next page.

Calculating the angular resolution (only WB10, WB20 and WB50):

The angular resolution can be defined as the spacing expressed in degrees (°) between two consecutive discrete points, i.e. the sequence of information provided by the encoder.

The angular resolution of a tape applied on either a curved or a circular surface results from the following calculation:

$$\text{Angular resolution} = \frac{\alpha}{\text{Number of information}}$$

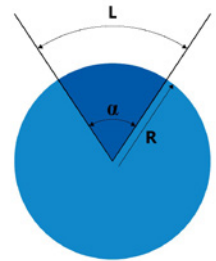

L is the length of the tape; and R is the radius of the curved or circular surface. The number of information is the number of pulses/counts provided by the measuring system for the whole tape length L.

As you can easily see in the Figure above, α is the magnitude of the angle corresponding to the length of the tape applied on the circular surface. The formula for calculating the magnitude of the angle α (i.e. the size of the arc) can be argued considering that, if the magnitude of the circumference ($2\pi R$) is 360° , then the magnitude of the tape angle will be 360° (circumference) or a fraction of 360° (arc).

$$\alpha = \frac{L \times 360}{2\pi R}$$



MOUNTING THE MAGNETIC TAPE

The number of information depends on the length of the tape and the technical characteristics of the installed sensor.

To calculate the number of information provided by the measuring unit, we must consider the length of the tape, the pole pitch of the tape and the interpolation factor used by the installed sensor.

The incremental tape can be up to 100 m long. The pole pitch is the distance between two consecutive poles which is 1 mm for WB10, 2 mm for WB20 and 5 mm for WB50 tapes. Finally we must calculate the interpolation factor using the following formula. For the resolution please refer to the data sheet of the sensor:

$$\text{Interpolation factor} = \frac{\text{pole pitch}}{\text{resolution}}$$

Next we need the number of poles, which can be calculated as follows:

$$\text{Number of poles} = \frac{\text{Length of the tape}}{\text{Pole pitch}}$$

Now we are able to calculate the number of information, which we needed for the angular resolution:

$$\text{Number of information} = \text{number of poles} \times \text{interpolation factor}$$

DECLARATION OF EC-CONFORMITY

WayCon Positionsmesstechnik GmbH
Mehlbeerenstrasse 4
82024 Taufkirchen / Germany

This is to certify that the products

Classification Magnetic scales
Series WB10, WB20, WB50, WBA2, WBAX and WBAZ
fulfill the current request of the following EC-directives:
EMV-directive 2014/30/EU
 2011/65/EU
applied harmonized standards:
CEI EN 61000-6-4, CEI EN 61000-6-2

The declaration of conformity loses its validity if the product is misused or modified without proper authorisation.

Taufkirchen, 02.10.2017

Andreas Träger, CEO